

INSTRUCTION MANUAL

7200 Monitor

Field Mount



Sira MC060083/00

Partech (Electronics) Ltd

Charlestown, St Austell
Cornwall, PL25 3NN, UK

Phone: +44 (0) 1726 879800

Fax: +44 (0) 1726 879801

email: sales@partech.co.uk website: www.partech.co.uk

Contents

Health and Safety Information.....	3
Introduction.....	4
MCERTS Product Certification.....	6
Installation	7
Basic Operation.....	10
Configuration.....	11
Calibration.....	13
Setup Wizard.....	17
Alarm Outputs.....	18
Analogue Output.....	20
Sensor Configuration.....	22
Advanced Sensor Setup.....	24
Instrument Setup.....	25
Clean Setup.....	27
Air Clean Setup.....	29
Diagnostics.....	31
Information.....	32
Instrument Security.....	33
Error Messages.....	34
Menu Structure.....	36
Sensor Defaults.....	37
Technical Specification.....	38
Technical Support.....	39
Preparation of Fullers Earth Solutions.....	40
Preparation of Formazin Turbidity Standard.....	41
Declaration of Conformity.....	43

Health and Safety Information

The following information is a guide and does not in anyway replace legal requirements for the handling of the equipment and chemicals or any safe working practise defined outside of this manual.

Care needs to be taken to ensure that the system can be accessed safely for calibration and maintenance.

To ensure that our products are safe and without risk to health, the following must be noted:

1. The relevant sections of these instructions must be read carefully before proceeding.
2. Warning labels on containers and packaging must be observed.
3. Installation, operation, maintenance and servicing must only be carried out by suitably qualified personnel and in accordance with the information given.
4. Standard safety precautions must be taken to avoid the possibility of an accident occurring in conditions of high pressure and/or high temperature.
5. Chemicals should be stored appropriately and protected from temperature extremes. Follow normal safe handling procedures.
6. When disposing of chemicals ensure that no two chemicals are mixed.

Electrical Connections

Please refer to the electrical installation section for connection details, all relevant regulations must be followed and the supply must be isolated before work is carried out.

Safety advice concerning the use of the equipment described in this manual may be obtained from:

Partech Electronics Ltd
111/113 Charlestown Road
Charlestown, St Austell
Cornwall PL25 3NN
United Kingdom
www.partech.co.uk

Introduction

General

The 7200 Monitor is used for processing and displaying the output signal from a Partech sensor. It combines a clear display of the measured parameter, a simple user interface, with good flexibility to enable configuration to satisfy the users needs. For remote signalling the 7200 has two alarm outputs and a single analogue output.

The 7200 Monitor has an IP65 enclosure and is suitable for outdoor use however a protective cover or outer enclosure is recommended to further protect the instrument from the elements.

Display

The 7200 display indicates the measured value with large numerals for good visibility with an additional status line that shows the current state of the alarm outputs, analogue output and any faults that are present. The display has a backlight to enable use of the monitor in low light conditions and also has a user settable contrast.

The measurement title, units and display range can all be user set to suit the sensor being used and the parameter being monitored.

Key Pad

A six key tactile membrane keypad is used for all configuration and operation of the 7200 Monitor, each key has a very positive operation enabling use even whilst wearing gloves.

Alarms

Two user configurable alarms are provided within the 7200, which can be used to signal high, low or fault alarm conditions. Each alarm output is a single pole change over relay which is normally energised (no alarm present) and de-energises when an alarm occurs (fail safe).

Analogue Output

The 7200 Monitor has a single analogue output that can be configured for voltage or current operation and can be set to operate over the whole measuring range or a portion of the measuring range. The output can also be configured for reverse operation (i.e. 20 to 4mA) should this be required.

When a fault condition occurs (see faults), the user can select whether the output indicates the last valid measurement, its maximum output value or its minimum output value. This is useful when the alarm outputs are not used and it is necessary to remotely determine the instrument's state.

Sensors

The 7200 Monitor can be used with the following Partech sensors:

TT Series	TT2000LA, TT2000LS, TT2i, TT10i, TT12i, TT20i
IR Series	IR8, IR15, IR40, IR100, IR12LS
IL Series	IL55, IL55BV2
ST Series	ST20 Range 0-xxxxx

Manual Conventions

This instruction manual describes the configuration and operation of the 7200 Monitor and where required includes some information regarding sensors. It is therefore very important that it is used in conjunction with the relevant sensor instruction manual. All dimensions stated in this manual are in millimetres unless otherwise stated.

The manual has been written on the basis that the user has a basic knowledge of instrumentation and an understanding of the type of measurement being made. Training in the use of the 7200 Monitor can be provided by Partech, please contact sales for further information.

MCERTS Product Certification

Increasingly, with 'Modern Regulation' and in order to strengthen its auditing of operators' self-monitoring arrangements, the Environment Agency is moving towards more efficient regulation through Operator and Pollution Risk Appraisal (OPRA), Operator Monitoring Assessment (OMA) and its Monitoring Certification Scheme (MCERTS)

MCERTS is now well established and is seen as a mark of quality. It provides a framework within which environmental measurements can be made in accordance with the Agency's quality requirements. The scheme covers a range of monitoring, sampling and inspection activities including product certification. Partech Instruments manufacture and supply the first certified Turbidity Monitoring System under the Environment Agency's MCERTS scheme for Continuous Water Monitoring equipment (CWM's).

The current performance standard for CWM's is available at:

<http://publications.environment-agency.gov.uk/pdf/GEHO0206BKGA-e-e.pdf>

The scheme is operated on behalf of the Environment Agency by Sira. The United Kingdom Accreditation Service (UKAS) accredits Sira to undertake the product and personnel certification activities which underpin the MCERTS scheme. The scheme provides a framework within which instruments and measurements can be made in accordance with the Agency's quality requirements.

Partech Instrument's Certified Turbidity System consists of the 7200 Monitor and Turbi-Tech 2000LS Sensor.

The system underwent laboratory testing in accordance with the MCERTS performance standard and can only be described as an MCERTS certified system when installed and operated as a system in accordance with recommended procedures. 7200 Monitors sold with any other sensor are not certified.

The system has been certified in the ranges 0-50FTU/FNU and 0-500FTU/FNU and to measure Turbidity.

Partech's Turbidity MCERTS certificate is available at:

<http://www.sira.co.uk/MCERTS/MC06008300.pdf>

For further information on the various MCERTS schemes visit:

<http://www.mcerts.net/>

Installation

Location

The field mounting version of the 7200 Monitor is housed in an IP65 enclosure and therefore is suitable for mounting outdoors, preferably located close to the sensor. It is advisable to mount the monitor in a location where it has some protection from the elements, this could be inside a GRP or metal cabinet, in a control room, or with a protective shield.

It is recommended that the monitor is located close to the sensor to simplify the setup and calibration of the system thus avoiding long walks between monitor and sensor.

Note: The maximum length of cable between the monitor and sensor is 100 metres.

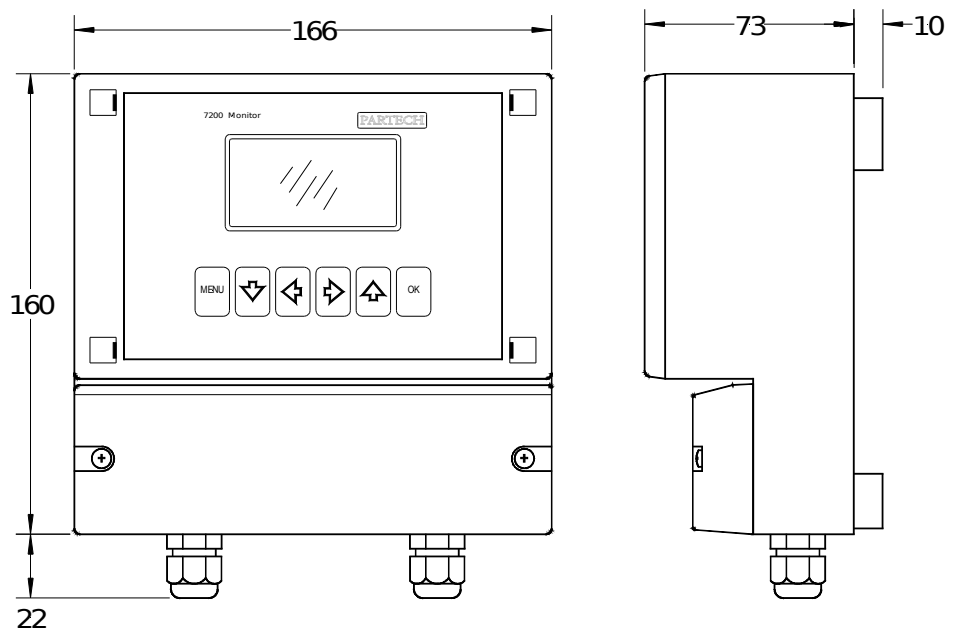

Figure 1 7200 Field Mount

Mounting

The 7200 Monitor enclosure is designed for wall mounting, the hole positions required for this are shown in Figure 2. A range of mounting hardware (such as handrail brackets, protective hoods and sensor brackets) is available from Partech, further details are available on request.

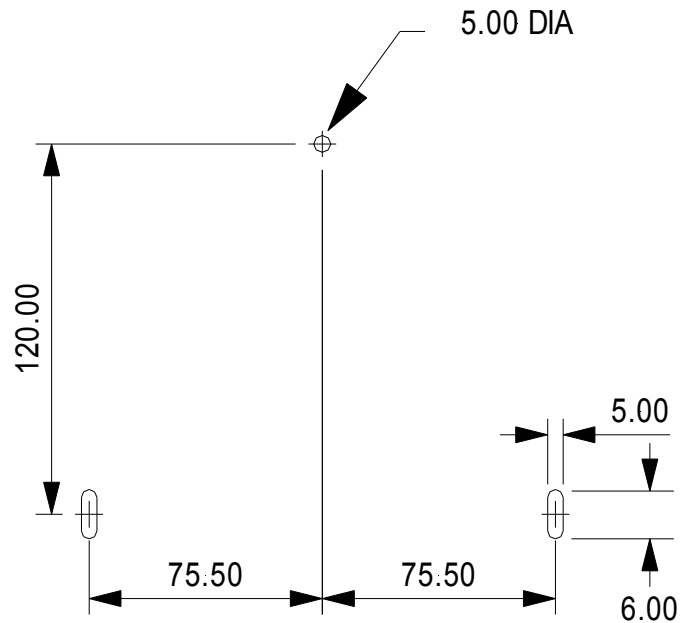

Figure 2 7200 Field Mount mounting hole positions

Electrical Connections

The 7200 Monitor electrical connections can be accessed by removing the terminal compartment cover.

The electrical supply to the unit should be installed such that there is a means of isolating the supply to the unit and the supply is protected with a fuse or trip. The instrument does have a supply fuse fitted internally.

WARNING: DISCONNECT THE MAINS SUPPLY BEFORE REMOVING THE TERMINAL COVER

The 7200 Monitor is supplied fitted with two PG11 cable glands fitted and has provision for a further two PG11 glands. If the cable being used is too large for the PG11 glands, the cable must be terminated externally to the unit and a suitable cable used for connection to the 7200. If any fitted cable glands are not used, these must be sealed to prevent the ingress of moisture into the unit.

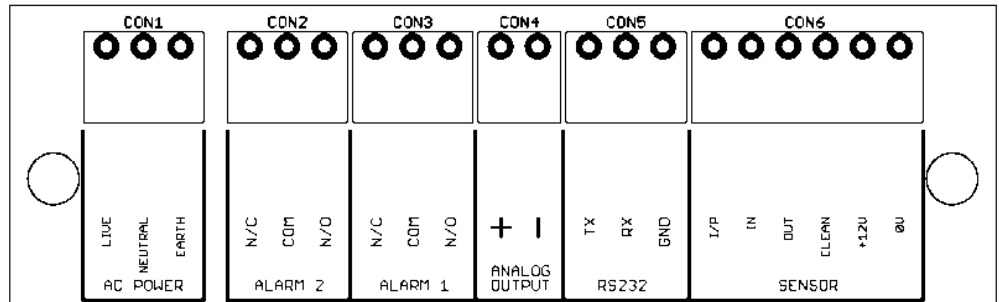

Figure 3 7200 Field Mount Connection Terminals

Terminal	Sensor Type			
	TT Series	IR Series	IL Series	ST Series
Sensor I/P	Yellow	White	White	White
In Opto	Black	-	-	-
Out Opto	Red	-	-	-
Clean	Green	-	-	-
Sensor 12V	Blue	Red	Red	Red
Sensor 0V	White	Black or Blue	Black or Blue	Black or Blue

Figure 4 Sensor Connection Detail

Note 1: The normal condition for the alarm outputs is when the instrument is powered and the alarm is off.

Note 2: The RS232 connections can be used to collect data from the 7200 and using a suitable serial cable for connection to a PC. Further details of the serial connection lead are available from Partech on request.

Basic Operation

Measure Mode

The normal operating mode for the 7200 Monitor is its measure mode and this is active when the measured value is displayed in large numbers. Whilst in measure mode the display value is continually updated based upon the current sensor input signal.

The display in measure mode also includes a status bar that scrolls through the status of the alarm and analogue outputs and if the instrument is locked. The status bar is also used to indicate any instrument faults that are present. During a clean cycle the status bar indicates the current stage of the clean cycle.

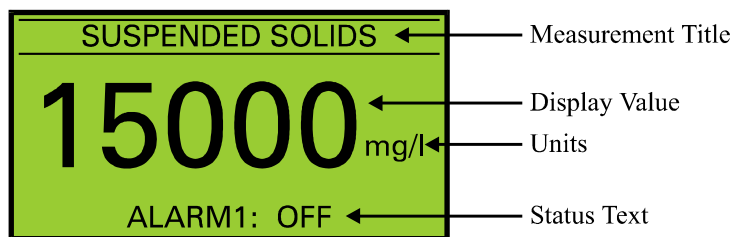

Figure 5 Measure Mode Display

Measurement Cycle

The measurement cycle is carried out in the background at all times when the instrument is switched on regardless of whether the instrument is in measure mode or not. It is therefore capable of updating the output signal and alarms when the user is navigating the menu structure in order to change the instrument configuration. The monitor performs five measurement cycles per second enabling a response time of one fifth of a second (Damping rate set to Instant – see damping).

Display

The resolution of the displayed value is determined by the sensor range setting such that only sensible display values are indicated, the same range also determines the calibration value range, alarm value range, and analogue output range.

The display units and measurement title is user selectable and should be chosen to suit the parameter being monitored and sensor being used.

Configuration

Menu Mode

To access the main menu, press the **MENU** key when the instrument is in measure mode. Pressing the **MENU** key when the main menu is displayed will return the instrument to the measure mode. When the main menu is displayed, the **↓↑** keys can be used to move the selection bar. Pressing the **OK** key will activate the selected item.

If the instrument is left in any display other than measure mode, it will automatically return to menu mode after one minute has passed with no key presses. (When the cycle alarm or cycle output facilities are being used the delay is 15 minutes)

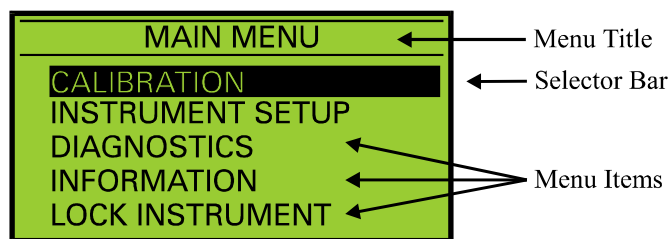

Figure 6 Menu Display

When a sub menu is displayed, pressing the **MENU** key will exit the current menu and return to the previous menu. If a menu consists of more than five items, **UP** and **DOWN** arrows will appear to indicate if there are menu items above or below those displayed.

Data Entry

To provide the user with a simply interface, the 7200 uses three methods of data entry for the setting of all the user configurable parameters. The various methods of user data entry used on the 7200 are described below:

User List Selection

This method of user data entry is used when a selection from a predefined list of option is required such as sensor type, display range and backlight mode. The list of possible selections will be displayed and a small tick will identify the current setting. If the list contains more than five items, small **UP** and **DOWN** arrows will appear on the display to indicate there are more items than that displayed. To make a selection, the selector bar can be moved using the **↓↑** keys, to select the required item. Pressing the **OK** key will select the highlighted item and a small tick will appear next to it. Pressing the **MENU** key will exit the list selection menu.

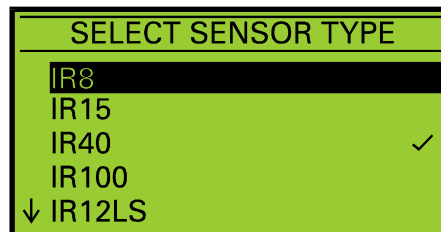

Figure 7 List Selection Display – note tick indicating current value

User Value Entry

When a numerical value is to be set, the current value will be displayed with a flashing cursor. The range of adjustment of the value is predefined and therefore only values within this range can be entered. To adjust a value, the $\leftarrow \rightarrow$ keys are used to select a digit and the $\downarrow \uparrow$ keys are used to increment/decrement the digit. When the new value has been set pressing the **OK** key will store it and exit from the value adjustment display. If the **MENU** key is pressed any changes that have been made will be lost and the value adjustment display will be exited.

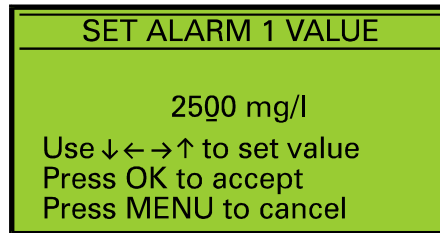

Figure 8 Value Entry Display

User Text Entry

Using this method of data entry, the user is able to enter or edit text and is used for the user defined measurement title and units. The text string is displayed with a flashing cursor indicating the selected character. The $\leftarrow \rightarrow$ keys are used to select a character, and the $\downarrow \uparrow$ keys to change the selected character. When all changes are complete press the **OK** key to store the text string. To exit without saving changes press the **MENU** key.

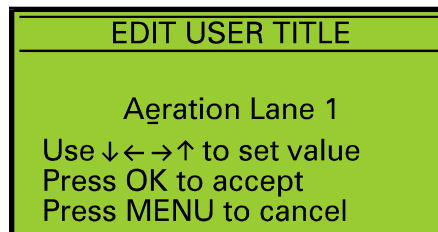

Figure 9 Text Entry Display

Calibration

Calibration - General

Calibration of the 7200 Monitor is very important, errors in the calibration process will affect the measurement performance of the instrument. The following section describes the various aspects of calibrating the 7200 Monitor and has been written with the understanding that the user has knowledge of the measurement being made.

When a new system is installed, a period of 4 hours should be allowed for the equipment to stabilise before calibration commences. This is to enable the system to adjust to the “new” ambient conditions. This should not be considered as a warm up time from power up, it allows the system to adjust from a warm store or office to a cold site.

Any containers used to store calibration samples should be cleaned prior to use. This is particularly important when performing the zero point calibration on a low range sensor.

The most accurate method of calibration is using a primary standard, i.e. calibration in the actual solution against a lab result. Where this is not possible or where the trend of the reading is necessary rather than an absolute value it is acceptable to use a secondary standard.

Please read this section together with the section titled ‘Calibration – Equipment and Procedures’ found in the instruction manual for the chosen sensor.

Note: Whenever the sensor type is changed, the factory default values for calibration are loaded for the new sensor type.

Methods of Calibration

Primary Standard

This method of calibration will give the best results however it does require the use of a laboratory to carry out a gravimetric analysis of the calibration solution. The result of the gravimetric analysis is used as the calibration value.

Secondary Standard

In cases where it is not possible to carry out calibration using a primary standard, secondary standards such as Fullers Earth or Formazin can be used. It is important to remember however that instruments calibrated in this way will give results based on the secondary standard used and this will differ from the results of a gravimetric analysis.

A guide to the preparation of Fullers Earth and Formazin solutions is located at the back of this manual.

Calibration Intervals

The 7200 Monitor and Sensor combination once calibrated will require calibration checking/re-calibration at 3-6 monthly intervals, however this does depend on the application. The calibration of the instrument can be effected by seasonal variations in the measured effluent, however only knowledge of the application can determine the re-calibration interval required.

Preparing For Calibration

To ensure that calibration will be as successful as possible the following should be observed:

1. Clean the whole sensor and at least 1 metre of cable.
2. The zero solution should be clean settled tap water for high range sensors and freshly distilled or de-mineralised for low range sensors.
3. A calibration solution will be required; ideally this should be greater than 75% of the intended measurement range.

Calibration Wizard

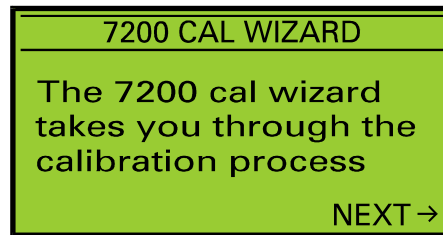

Figure 10 Calibration Wizard

The 7200 calibration wizard guides the user through the important process of calibrating the instrument. When the equipment is first installed, the setup wizard should be used to ensure that all the essential settings have been properly set. Once the setup wizard has been completed, the instrument should respond to changes to the sensor signal (for example placing the sensor into the zero solution and then into the calibration solution). Although the instrument is responding, the factory default calibration values are used until user calibration is carried out.

Before using the calibration wizard, the guideline described in the preparation for calibration section above should be observed.

Cal Wizard Keys

Once the calibration wizard has been entered, the **MENU** key can be used to exit at any time. Pressing the **→** key moves forward to the next step and pressing the **←** moves back to the previous step. Pressing the **OK** key will activate the displayed activity.

Cal Wizard Stages

The Cal Wizard guides the user through the process of setting the instrument zero and span. For more information about setting zero and span, refer to the applicable section of this manual.

Set Zero

This menu is used to set the instrument display zero for the attached sensor. To zero the instrument, go to the Calibration menu, select Set Zero and press the **OK** key. Immerse the sensor into the zero solution and press the **OK** key. The 7200 Monitor collects data for the zeroing operation for approximately 5 seconds to ensure that the zero is set accurately. During this period do not move the sensor, as this could effect the zero operation. If the zeroing process is successful, the monitor will return to measure mode and the display value will be zero. If a problem occurs during the zeroing operation, an error message will be displayed and the monitor will return to the Calibration menu.

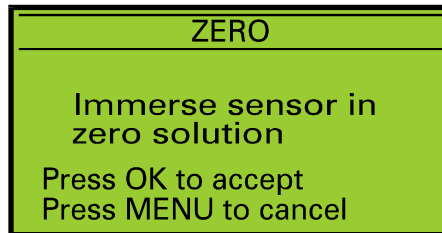

Figure 12 Zero - Preparation

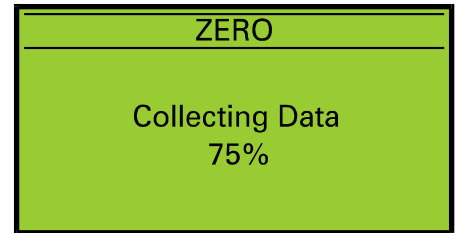

Figure 11 Zero – Collecting Data

Set Span

The Set Span function is used to set the calibration point for the instrument, which is used in the calculation of the displayed value. To calibrate the instrument, go to the Calibration menu, select Set Span and press the **OK** key.

Note: If an online calibration is being carried out, whilst in measure mode check that the display value is stable – it may be necessary to increase the damping level to stabilise the display value.

Step 1. Calibration Value Entry

The calibration value can be set to a value between 10 – 100% of the currently selected measuring range using the **↓←→↑** keys. This value should be set to the value of the calibration solution. Once the correct value has been set press the **OK** key. Pressing the **MENU** key will exit the Set Span operation.

Note: The calibration value can only be set between 10 –100% of the display range.

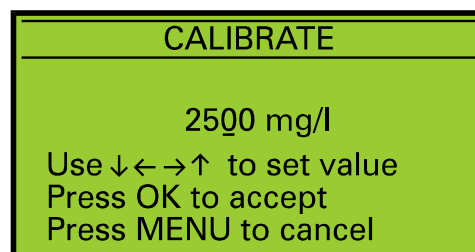

Figure 13 Set Span –Calibration Value Entry

Step 2. Calibrating

As indicated by the on display instructions, immerse the sensor into the calibration solution and press the **OK** key. The 7200 Monitor collects data for the spanning operation for approximately 5 seconds to ensure that the span is set accurately. During this period do not move the sensor, as this could effect the span operation. If the spanning process is successful, the monitor will return to measure mode and the display value should be correct for the calibration solution. If a problem occurs during the spanning operation, an error message will be displayed and the monitor will return to the Calibration menu.

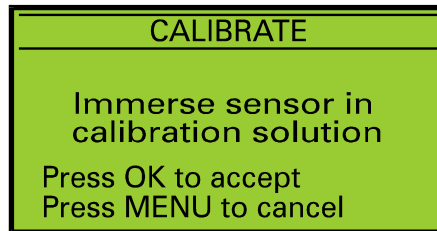

Figure 14 Set Span - Preparation

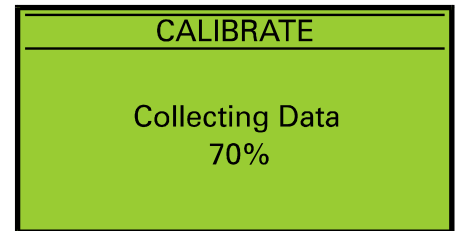

Figure 15 Set Span – Data Collection

Take Sample

The Take Sample and Enter Sample Result facilities are provided to allow calibration to be carried out retrospectively based upon stored information. An example of this is where the value of the calibration solution is not known at the time of calibration and an estimated value was used to set the instrument span. The take sample menu is used to store the sensor signal in the calibration solution for later use.

From the Calibration menu, select Take Sample and press the **OK** key. With the sensors immersed in the calibration solution, (The display value must be stable – this can be checked when in measure mode) press the **OK** key. The 7200 Monitor collects data for the take sample operation for approximately 5 seconds; during this period do not move the sensor. If the take sample process is successful, the monitor will return to measure mode. If a problem occurs during the zeroing operation, an error message will be displayed and the monitor will return to the Calibration menu.

Enter Sample Result

When the take sample operation has been carried out, and the correct value for the calibration solution is known, the new calibration value can be entered using the Enter Sample Result menu.

To enter the new calibration value, from the calibration menu, select the Enter Sample Result menu and press the **OK** key. The calibration value can be set to a value between 10 – 100% of the currently selected measuring range using the **↓←→↑** keys. This value should be set to the value of the calibration solution. Once the correct value has been set press the **OK** key. Pressing the **MENU** key will exit the Set Span operation.

Note: The calibration value can only be set between 10 –100% of the display range.

Setup Wizard

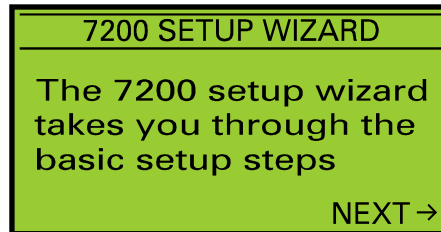

Figure 16 Setup Wizard

The 7200 setup wizard simplifies the process of setting up the instrument when first installed by guiding the user through the basic (but important!) configuration steps. Prior to using the setup wizard, the following information should be obtained:

Sensor Type	Required measuring range
Title of measurement	Measurement units
Type and Value of alarms	Type and Range of analogue output

Setup Wizard Keys

Once the setup wizard has been entered, the **MENU** key can be used to exit at any time. Pressing the **→** key moves forward to the next step and pressing the **←** moves back to the previous step. Pressing the **OK** key will activate the displayed activity.

Setup Wizard Stages

The Setup Wizard guides the user through the configuration of the following items, for more information about the item, refer to the applicable section of this manual.

1. Sensor Type
2. Measurement Title
3. Units
4. Measurement Range
5. Alarm 1 Type
6. Alarm 1 Value
7. Alarm 2 Type
8. Alarm 2 Value
9. Output Type
10. Output Low Value
11. Output High Value

Alarm Outputs

The 7200 Monitor has two alarm outputs designated Alarm 1 and Alarm 2. Each alarm has a single pole changeover output that signals the alarm condition. During normal operation when the alarm is not active the alarm output will be in its NORMAL condition, the N/O (normally open) contact will be open and the N/C (normally closed) contact will be closed. When the alarm is active the alarm output will be in its ALARM condition and therefore the N/O contact will be closed and the N/C contact will be open.

Note: The alarm output will enter its ALARM condition if the power to the instrument is disconnected.

The alarms are identical and therefore the configuration procedure is the same for each and is carried out as described in the following sections:

Alarm Value

The alarm value can be set to any value within the currently selected measuring range (Sensor Menu). The value can be set using the $\downarrow \leftarrow \rightarrow \uparrow$ keys, press **OK** to accept the new value or **MENU** to cancel and exit.

Note: The value can only be set within the range of the selected sensor range.

Alarm Type

The alarm type can be selected from the following:

Off

If the alarm is set to OFF, the output will remain in its NORMAL condition whilst the instrument is switched on regardless of the measured value and other alarm settings.

Low

The output will go into the ALARM condition whenever the measured value is less than or equal to the alarm value. The output will return to its NORMAL condition when the measured value is greater than the alarm value.

High

The output will go into the ALARM condition whenever the measured value is greater than or equal to the alarm value. The output will return to its NORMAL condition when the measured value is less than the alarm value.

Fault

When the alarm type is set to fault, the alarm output will enter the ALARM condition when any of the selected faults occur. The output will return to its NORMAL condition when all the selected faults are not active.

Alarm Hysteresis

In a normal condition an alarm turns on and off at the same value. For example, if a high alarm turns on at 2000mg/l the alarm occurs when the reading increases to 2000mg/l. When it decreases through 2000mg/l the alarm turns off.

Some applications may demand that the alarm turns off at a different value, for a high alarm this would be value lower than the alarm value, and for a low alarm this would be a value higher than the alarm value.

The hysteresis value determines the difference between the alarm switch on point and the alarm switch off point. In the case of a high alarm, hysteresis causes the alarm to turn off at a value that is less than the alarm value. For a low alarm, hysteresis causes the alarm to turn off at a value greater than the alarm value.

The alarm hysteresis value can be adjusted between 0 – 10% of the selected display range using the $\downarrow\leftarrow\rightarrow\uparrow$ keys. Pressing **OK** key will enter the new value, pressing the **MENU** key cancels any changes made and exits from the hysteresis set up.

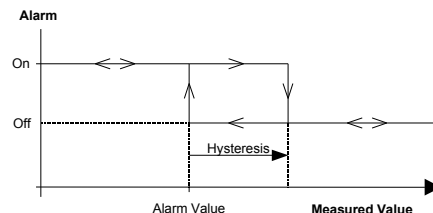

Figure 17 Low Alarm with hysteresis

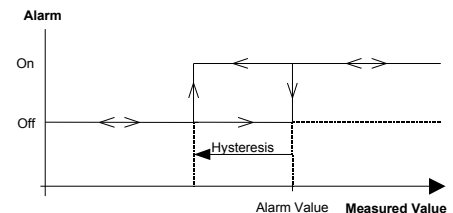

Figure 18 High Alarm with hysteresis

Fault Alarm Setup

When the alarm type is set to fault, the alarm fault setup determines which faults the alarm output will signal (at least one fault must be selected for the alarm output to work).

The faults that can be signalled by the alarm are displayed as a list, the enabled faults are indicated by small ticks. To enable a fault, use the $\downarrow\uparrow$ keys to highlight the required fault and press the **OK** key. A small tick will appear next to the selected fault. To disable a fault, use the $\downarrow\uparrow$ keys to select it and press the **OK** key, the small tick will disappear.

Note: The instrument faults are defined elsewhere within this manual.

Delay to Set

A delay can be introduced between conditions for an alarm turning on being met and the alarm actually turning on. At any time during a delay, if the conditions for turning the alarm on disappear, then the delay will end and the alarm will remain off (no change). The delay to set can be varied between 0-600 seconds using the $\downarrow\leftarrow\rightarrow\uparrow$ keys. Pressing **OK** will store the new value.

Delay to Reset

A delay can be introduced between conditions for an alarm turning off being met and the alarm actually turning off. Such a delay can be varied between 0-600 seconds. At any time during a delay, if the conditions for turning the alarm off disappear, then the delay will end and the alarm will remain on (no change).

Test Alarm Output

This facility enables the alarm output to be tested to enable verification of its operation and also to check that equipment connected to it is working properly. By using the $\downarrow\uparrow$ keys the alarm output can be toggled between its NORMAL (OFF) and ALARM (ON) conditions. Press the **OK** or **MENU** key to exit.

Alarm Test Cycle

The alarm test cycle can be used when installing and configuring remote equipment on the alarm output. The alarm output is automatically toggled between its NORMAL (OFF) and ALARM (ON) conditions every fifteen seconds and will continue to do so for fifteen minutes after which the instrument will return to the measure mode. To exit the alarm test cycle, press the **OK** or **MENU** key.

Analogue Output

The following section describes the setting up of the analogue output. The analogue output has three modes of operation as shown in the table below:

Output Type	Low	High
4 – 20 mA	4 mA	20 mA
0 – 20 mA	0 mA	20 mA
0 – 5 V	0 V	5 V

The output can be set to work over the whole of selected measurement range or a portion of it by the setting of the output low and high values. It is also possible to configure the output to work reverse to normal, i.e. a 4 – 20 mA output where 20 mA corresponds to the zero display value and 4 mA corresponding to the full scale value.

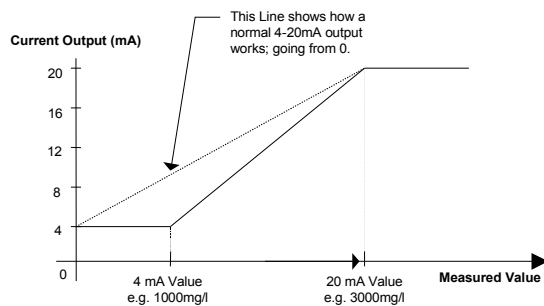

Figure 19 Example output configuration (4-20mA)

Set Output Low

Use the $\downarrow \leftarrow \rightarrow \uparrow$ keys to set the required measurement value to produce the output low signal. Press **OK** to accept the new value or **MENU** to cancel the new value.

Note: The value can only be set within the range of the selected sensor range.

Set Output High

Use the $\downarrow \leftarrow \rightarrow \uparrow$ keys to set the required measurement value to produce the output high signal. Press **OK** to accept the new value or **MENU** to cancel the new value.

Note: The value can only be set within the range of the selected sensor range.

Select Output Type

On entering the output type menu the current setting is indicated by a tick. Use the $\downarrow \uparrow$ keys to move the select bar to the required output type. Press the **OK** key to make the selection, a tick will appear against the selection. Press the menu key to exit the output type menu.

Fault Output Mode

When any of the fault conditions occur, the output can be configured to go to one of three values, two of which can be used to remotely detect the instrument fault.

Last Valid Measurement: The output will be held at the last value that was measured before the fault occurred and will remain held until the fault is cleared.

High/Low Value: During a fault condition the output will go to its high or low value as indicated in the table above for the selected output type.

On entering the fault condition output menu the present setting is indicated by a tick. Use the $\downarrow\uparrow$ keys to move the select bar to the required fault output. Press the **OK** key to make the selection, a tick will appear against the selection. Press the menu key to exit the output type menu.

Fault Output Setup

The fault output setup determines which faults will cause the analogue output to enter its fault mode. If a fault occurs that is not enabled, the output will remain at its last value until that fault has cleared.

The faults that can be signalled by the analogue output are displayed as a list; the enabled faults are indicated by small ticks. To enable a fault, use the $\downarrow\uparrow$ keys to highlight the required fault and press the **OK** key. A small tick will appear next to the selected fault. To disable a fault, use the $\downarrow\uparrow$ keys to select it and press the **OK** key, the small tick will disappear.

Note: The instrument faults are defined elsewhere within this manual.

Test Output

This facility enables the analogue output to be tested to enable verification of its operation and also to check that equipment connected to it is working properly. By using the $\downarrow\uparrow$ keys the output signal can be increased/decreased over its working range in fixed steps. Press the **OK** or **MENU** to exit.

Output Test Cycle

The output test cycle can be used when installing and configuring remote equipment on the analogue output. The analogue output is automatically swept from its low to high value enabling the operator to view the result on the remote equipment. The output is swept for fifteen minutes after which the instrument will return to the measure mode. To exit the output test cycle, press the **OK** or **MENU** key.

Sensor Configuration

The 7200 Monitor can be used with several different Partech sensors, further details of each type can be found in the relevant instruction manual.

Select Sensor Type

The sensors that can be configured for use with the 7200 Monitor are displayed as a list, a small tick indicates the currently selected sensor type. To select a different sensor type, use the **↓↑** keys to highlight the required sensor and press the **OK** key. A small tick will appear next to the required sensor type. Press the **MENU** key to exit the sensor type selection menu.

Sensor Types	Sensor Range (typical)
IR8	0 – 20000 mg/l
IR15	0 – 10000 mg/l
IR40	0 – 1500 mg/l
IR100	0 – 200 mg/l
IR12LS	0 – 500 FTU
TT2000LA	0 – 20000 mg/l
TT2000LS	0 – 500 mg/l
TT10i/20i	0 – 20000 mg/l
TT2i/12i	0 - 500 mg/l
IL55/IL55BV2	0 – 5% SS
ST20	0 – 200mg/l
	0 – 1500mg/l
	0 – 10000mg/l
	0 – 30000mg/l

NOTE: When the sensor type is changed, the sensor defaults for the new sensor are loaded and will over write any settings that have been made with the previous sensor.

Select Display Range

The display range setting determines the range and resolution of the displayed measured value, a default range is loaded when the sensor type is changed.

Range	Resolution
0 – 10.00	0.01
0 – 100.0	0.1
0 – 1000	1
0 – 10000	10
0 – 50000	100

Set Damping Rate

The 7200 Monitor has the ability to apply damping to the incoming sensor signal such that a stable measurement value can be displayed. This is essential in applications where the effluent being monitored produces a fast varying sensor signal such as in an aeration process.

The response time quoted for each damping rate is indication of the monitor's performance when a step change of 0 to 100% occurs on the sensor input. This can be useful when selecting the damping rate to be used for a particular application.

Damping Rate	Response Time (Seconds)	Typical Use
Instant	0.2	Instrument Demonstration
Very Fast	1	
Fast	10	Final Effluent
Medium	30	
Slow	60	Aeration Lane
Very Slow	120	

Air Clean Option

If the 7200 Monitor is being used with a Partech Air Clean System, this menu is used to enable the air clean function. Selecting yes will enable air clean operation and the air clean setup menu will be displayed on the Instrument Config menu.

Advanced Sensor Setup

The advanced sensor menu allows the user adjustment of important sensor related settings. These settings can have a major impact on the operation/configuration of the instrument and should only be altered by experienced users or under the supervision of Partech.

Select Equation

This is used to determine the type of equation used to determine the measured value, only certain equations can be used for each type of sensor.

Adjust Exp Constants

These values are used to perform linearisation on certain sensor types. The default values have been determined through extensive testing and should produce acceptable results in most applications. If the linearity of the system is not acceptable, please contact Partech technical support.

Adjust X Values

These values along with the Y values are used to perform linearisation on certain sensor types by means of a lookup table. The X values represent the input values to the table and the Y values are used to determine the linear output values. For further information on the use of lookup table linearisation please contact Partech.

Adjust Y Values

See Adjust X values above.

Sensor Defaults

It is sometimes necessary to restore the default values for the selected sensor type such that the instrument is in a known state. To load the sensor defaults, select Sensor Defaults and press **OK**. To prevent accidental use, the user password must be entered prior to confirming the operation.

Instrument Setup

Measurement Title

This menu is used to select the measurement title displayed in measure mode. The user can select from a list of predefined titles or enter a custom title. To select a measurement title, use the $\downarrow\uparrow$ keys to highlight the required title and press the **OK** key. If a predefined title is selected, a small tick will appear next to the selected title. If the user-defined option is selected, a new screen will be displayed which allows editing of the user defined title.

User Defined Title

To edit the user defined title, use the \leftrightarrow keys to select a character, and the $\downarrow\uparrow$ keys to change the selected character. When all changes are complete press the **OK** key to store the measurement title. To exit without saving changes press the **MENU** key.

Display Units

The measurement units displayed in measure mode can be selected using this menu such that they are appropriate for the measurement being made. The user can select units from a predefined list, enter custom units (user defined) or switch off the display of units.

To select the measurement units, use the $\downarrow\uparrow$ keys to highlight the required title and press the **OK** key. If a predefined title is selected, a small tick will appear next to the selected title. If the user-defined option is selected, a new screen will be displayed which allows editing of the user defined units.

User Defined Units

To edit the user defined units, use the \leftrightarrow keys to select a character, and the $\downarrow\uparrow$ keys to change the selected character. When all changes are complete press the **OK** key to store the new units. To exit without saving changes press the **MENU** key.

Linked Units

The m/g and g/l units are linked such that changing from one to the other will cause a change in the display range such that the display value is appropriate for the units selected. The linked relationship between units and ranges is shown in the table below.

Note: Changing from/to any units other than those shown will not effect the display range.

Old Range	Old Units	Units Changed To:	New Range
0 – 10000	mg/l	g/l	0 – 10.00
0 – 50000	mg/l	g/l	0 – 100.0
0 – 10.00	g/l	mg/l	0 – 10000
0 – 100.0	g/l	mg/l	0 – 50000

Display Contrast

When this menu is selected, the display contrast can be adjusted over the range 0% (light) to 100% (dark) using the $\downarrow\uparrow$ keys. Pressing the **OK** key stores the new contrast setting and exits the menu, pressing the **MENU** key exits losing any changes made to the contrast setting.

Beeper

This option allows the beeper to be turned on or off, a small tick indicates the current setting. To change the beeper setting, use the $\downarrow\uparrow$ keys to select the required setting and press **OK**. Press **MENU** to exit the beeper menu.

Backlight

The backlight can be set to one of three modes, On, On after key press (the backlight stays on for 5 seconds after a key is pressed) or Off. The current backlight mode is indicated by a small tick, to change the backlight mode, use the $\downarrow\uparrow$ keys to select the required mode and press **OK**. Press **MENU** to exit the backlight menu.

Language

This facility is used to select the operating language of the instrument and is configured using the list select method of data entry.

Change Password

The user password used when the instrument is locked and unlocked can be adjusted using this menu. The first stage in changing the password is to enter the existing password, which is done using the $\downarrow\leftarrow\rightarrow\uparrow$ keys. Once the old password has been entered, press the **OK** key to proceed to the next stage, which is the entry of the new password. The new password can be entered using the $\downarrow\leftarrow\rightarrow\uparrow$ keys and pressing the **OK** key will store the new password. At any stage whilst the password is being changed, pressing the **MENU** key will exit the menu and the old password will be unchanged.

Note: The factory default password is 1000, if the original password has been forgotten please contact Partech technical support.

Reset Instrument

It is sometimes necessary to restore the default values for all the user configurable parameters such that the instrument is in a known state. To load the user defaults, select Reset Instrument and press **OK**. To prevent accidental use, the user password must be entered prior to confirming the operation.

Clean Setup

The clean setup and manual clean menu's are only display if the selected sensor type is capable of auto cleaning. If a non self-cleaning sensor is being used, the following section is not applicable.

The Partech range of self cleaning sensors are designed such that the 7200 Monitor determines when a clean cycle is performed. During a clean cycle, the 7200 Monitor display value, alarm outputs and analogue output are all frozen, and are only unfrozen once the clean cycle is complete. The stage of the clean cycle is indicated on the measure mode status bar throughout the clean cycle.

For further information regarding the clean operation of a self-clean sensor, please refer to the appropriate sensor instruction manual.

Set Clean Interval

The clean interval determines the length of time between the sensor being cleaned. The user can select a clean interval between 30 minutes and 24 hours, using the value adjustment method of data entry.

Note: The clean interval is entered in hours and minutes. (HH:MM)

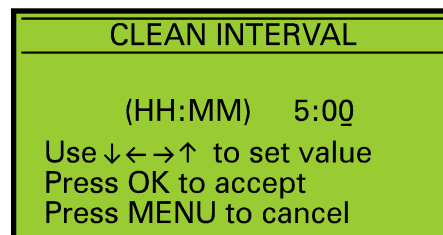

Figure 20 Clean Interval

Clean Mode

The clean mode menu is used to set whether the sensor will operate in its Normal or Reverse mode. The default setting for clean mode is Normal and this is suitable for most applications.

Normal Mode

In this mode, the sensor is measuring most of the time with the sensor probes extended. The clean cycle causes the retraction of the sensor probes into the sensor housing such that the probes are cleaned. The probes are then extended back to the measuring position and measurement recommences.

Reverse Mode

When the sensor is used in reverse mode, the sensor probes are held in the fully retracted position for the majority of time and a stored measurement is used for the display value, alarm and analogue outputs. The clean interval is used to determine when the sensor probes are extended. Once fully extended a measurement is performed and the stored value is updated. The sensor probes are then retracted to the fully in position.

Clean Information

This display provides general information regarding the sensor cleaning process.

Time until clean

This indicates the time until the next clean cycle in hours, minutes and seconds.

Clean Count

The clean count indicates the number of cleans that the sensor has performed since it was installed or last serviced, and the set service life that has been set.

Service Due

Using the clean count and service life, the number of days until a service is required is calculated and displayed. This is very useful in planning the servicing of a self-clean sensor.

Service Life

The service life is the number of cleans that the sensor can perform before requiring a service (replacement of wiper and sealing rings etc.). The default value is 3500 cleans and this is suitable for most applications. However where the application causes severe wear of the wiper and sealing rings, the service life should be reduced. When the service life has been reached a fault message indicating this is displayed in measure mode.

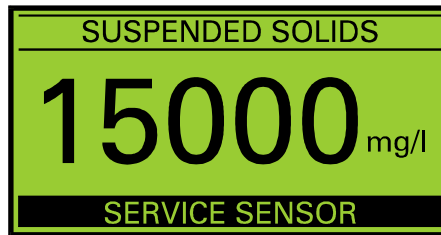

Figure 21 Service Sensor Fault Message

Reset Clean Count

When the sensor has been serviced, this menu can be used to reset (zero) the clean count and clear the service sensor fault.

Air Clean Setup

The air clean setup and manual air clean menu's are only display if the air clean option has been enabled on the sensor setup menu. The air clean option should only be enabled when the 7200 is being used with a Partech air clean system. If an air clean system is not being used, the following section is not applicable.

Partech air clean systems are designed such that the 7200 Monitor controls when an air clean cycle is performed. During an air clean, the 7200 Monitor display value, alarm outputs and analogue output are all frozen, and are only unfrozen once the air clean is complete. During an air clean, a countdown of the remaining time is indicated on the measure mode status bar.

For further information regarding the air clean system, please refer to the appropriate air clean system instruction manual.

Set Clean Interval

The clean interval determines the length of time between the sensor being cleaned. The user can select a clean interval between 30 minutes and 24 hours, using the value adjustment method of data entry.

Note: The clean interval is entered in hours and minutes. (HH:MM)

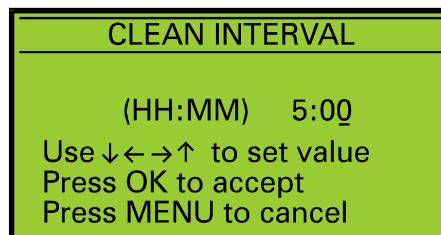

Figure 22 Clean Interval

Clean Duration

The length of time that the air pump is running during a clean is set by the clean duration value. The clean duration should be set to provide adequate cleaning of the sensor for the application in which it is being used.

Settling Time

The settling time determines the length of time after the air pump has stopped before the instrument returns to live measurements. The purpose of the settling time is to ensure that the display value is not effected by bubbles or turbulence caused by the cleaning process.

Clean Information

This display provides general information regarding the sensor cleaning process.

Time until clean

This indicates the time until the next clean cycle in hours, minutes and seconds.

Clean Count

The clean count indicates the number of air cleans that have been completed since the air pump was installed or last serviced.

Run Time

The run time displays the accumulated length of time the air pump has been running.

Service Life

The service life is the number of hours that the pump can be used. When the service life has been reached a fault message indicating this is displayed in measure mode.



Figure 23 Service Air Pump Fault Message

Reset Clean Count

When the air pump has been serviced, this menu can be used to reset (zero) the air clean count and clear the service air pump fault.

Diagnostics

The diagnostics menu provides information regarding the internal setup and operation of the instruments and is a very useful facility in assisting problem diagnosis. If a problem has occurred, contact Partech technical support for assistance.

Sensor Input

This display indicates the input signals from the sensor, U: is the raw signal from the sensor D: is the raw sensor signal with damping applied, S: is the approximate supply current to the sensor, L: is an internally used version of the damped sensor signal and M: is the display value.

Sensor %

This is a bar graph display of the undamped and damped sensor signals on a 0 to 100% scale, where 100% equates to the sensors upper range value.

Calibration Values

This indicates the internal values used to store the calibration and sensor setup data.

Factory Values

These values are set during factory calibration of the unit.

Diagnostic Values

These are additional values that are helpful when diagnosing instrument problems.

Diagnostic Download

This facility allows the downloading of the calibration, factory and internal values using the RS232 serial interface.

Opto Inputs

This display indicates the status of the opto-input signals from self-cleaning sensors.

ADC Inputs

The analogue to digital converter input values can be viewed using this menu.

Information

Statistics

View Statistics

The measurement statistics are updated continually when the instrument is operating and provide a useful indication of how the application is varying. The statistics are reset when the instrument is powered up and are therefore only valid from that point. The statistic values can be viewed using the View Statistics menu.

Set Average Period

The average period determines the length of time measurement data is collected for use in calculating the statistics average value. The average period can be set in the range 10 to 100 seconds, and is adjusted using the $\downarrow\leftrightarrow\uparrow$ keys. Pressing the **OK** key stores the new setting.

Download Statistics

This facility allows the downloading of the statistic values using the RS232 serial interface.

Reset Statistics

The statistic values can be reset using this menu.

Software Version

This display indicates the software version and serial number of the instrument and is useful for recording and problem diagnosis.

Contact Information

This display provides contact information for Partech (Electronics) Ltd.

Instrument Security

The 7200 Monitor can be locked to prevent unauthorised access to the configuration menu's by using a password. The user password is a 4 digit number that can be set to any value the user chooses. When supplied new, the user password is set to 1000, we recommend that this is changed when the instrument is installed.

Note: The factory default password is 1000, if the original password has been forgotten please contact Partech technical support.

Lock Instrument

To lock the instrument, this menu is used. The user will be prompted for the entry of the user password, when entered correctly the instrument will be locked. The instrument can only be locked with the correct user password thus avoiding accidental/unauthorised locking.

Change Password

The method of changing the user password is described in the instrument configuration section of this manual.

Error Messages

When the instrument detects an error condition, an error message will be displayed. All the error messages are described below. Certain error/fault conditions can be used in the fault setup of the alarms and analogue output and are identified by a *.

Sensor

*No Sensor **

No sensor detected on input to monitor if sensor is connected and wiring is okay either sensor fault or monitor fault.

*Sensor Low Limit **

Sensor input signal is too low possible, sensor fault.

*Sensor High Limit **

Sensor input signal is too high possible, sensor fault.

Measure Mode

*Display Over Range **

Calculated display value greater than selected display range maximum, either change display range or check calibration is correct.

*Display Under Range **

Calculated display value is less than selected display range minimum, check calibration.

Self Clean Sensors

*Clean Fault **

During a clean cycle the sensor detected a fault. Inspect sensor for damage and/or excess fouling – if there is no evidence of this remove and reapply power to the monitor and observe the clean operation.

*Clean Time Out **

The clean cycle took too long to complete. Inspect sensor for damage and/or excess fouling – if there is no evidence of this remove and reapply power to the monitor and observe the clean operation.

*Service Sensor **

Sensor requires servicing (clean count is greater than service life). Service sensor then use reset clean count to zero clean count and clear the service sensor fault.

*Std Error **

The standardise sensor reading is outside of the allowed limits. Check sensor for excess fouling, scratched/damaged glass tubes or other damage. If nothing is found remove and reapply power to the monitor and use manual clean to activate a clean cycle. If the fault reoccurs, contact Partech technical support for assistance.

Calibration

Not Available - Sensor Fault

If one of the above sensor faults is present, it is not possible to perform a calibration. Clear the sensor fault and try again.

Sensor Input Too High (Set Zero)

The data collected for the zero operation was above the allowed maximum for a zero operation. This can be caused by a dirty zero solution, fouling on the sensor or a fault with the sensor.

Sensor Input Too Low (Set Zero)

The data collected for the zero operation was below the allowed minimum for a zero operation. This generally indicates that the sensor is faulty.

Sensor Input Too Low (Set Span)

The data collected for the calibration operation was below the allowed minimum for the span to be set. This occurs when sensor signal in the calibration solution is too close to the sensor signal in the zero solution. This can be caused by a too clear calibration solution, the wrong sensor type or a fault with the sensor.

Air Clean Systems

Service Air Pump *

The air clean pump requires servicing (pump run hours are greater than service life). Service the air pump then use reset clean count to zero pump run time and clear service sensor fault.

Menu Structure

Manual Clean*

Calibration

Calibration Wizard

Set Zero

Set Span

Take Sample

Enter Sample Result

Instrument Configuration

Setup Wizard

Alarm 1 Setup

Set Alarm Value

Alarm Type

Alarm Hysteresis

Fault Alarm Setup

Delay To Set

Delay To Reset

Test Alarm

Cycle Alarm

Alarm 2 Setup

Alarm Value

Alarm Type

Alarm Hysteresis

Fault Alarm Setup

Delay To Set

Delay To Reset

Test Alarm

Cycle Alarm

Output Setup

Set Output Low

Set Output High

Select Output Type

Fault Output Mode

Fault Output Setup

Test Output

Cycle Output

Sensor Setup

Select Sensor Type

Set Display Range

Set Damping Rate

Air Clean Option

Advanced Menu

Select Equation

Adjust Exp Constants

Adjust X Values

Adjust Y Values

Sensor Defaults

*Clean Setup**

Clean Interval

Clean Mode

Clean Information

Service Life

Reset Clean Count

*Air Clean Setup***

Clean Interval

Clean Duration

Settling Time

Service Life

Clean Information

Reset Clean Count

Instrument Setup

Measurement Title

Display Units

Display Contrast

Beeper

Backlight

Language

Change Password

Reset Instrument

Diagnostics

Sensor Input

Sensor %

Up Time

Calibration Values

Factory Values

Diagnostic Values

Diagnostic Download

Opto Inputs

ADC Inputs

Information

Statistics

View Statistics

Set Average Period

Download Statistics

Reset Statistics

Software Version

Contact Information

Website Address

Email Address

Lock Instrument

* Only visible/selectable when a self cleaning sensor type is selected

** Only visible when the air clean option is enabled.

Sensor Defaults

The sensor default values are shown in the table below:

Sensor Type	Calibration Value	Display Range	Units	Equation	
IR8	20	0 – 100.0	mg/l	Exp	
IR15	10000	0 – 10000	mg/l	Exp	
IR40	1500	0 – 10000	mg/l	Exp	
IR100	200	0 – 1000	mg/l	Exp	
IR12LS	500	0 – 1000	FTU	Lin	
TT2000LA	10000	0 – 50000	mg/l	Exp	
TT2000LS	500	0 – 1000	mg/l	Lin	
TT10i/20i	10000	0 – 50000	mg/l	Exp	
TT2i/12i	500	0 – 1000	mg/l	Lin	
IL55/IL55BV2	50	0 – 100.0	% SS	Lin	
ST20	0-200	200	0 - 1000	mg/l	Exp
	0-1500	1500	0 - 10000	mg/l	Exp
	0-10000	10000	0 - 10000	mg/l	Exp
	0-30000	20	0 - 50000	mg/l	Exp

Technical Specification

General

Supply Voltage	85-264VAC, 50/60 Hz,
Power Consumption.....	15 VA
Supply Fuse.....	1.6A Anti surge 20 x 5mm (Fitted Internally)
Operating Temperature.....	0 to 50°C
Storage Temperature.....	-20 to 70°C
Display Resolution.....	0.1%
Response Time.....	0.2 to 120 Seconds (User selectable)
Linearity.....	(Refer to sensor specification)
Accuracy.....	(Refer to sensor specification)
Repeatability.....	(Refer to sensor specification)

Alarm Outputs

Number of Outputs.....	2 SPCO
Alarm Types.....	Low, High, Fault (User configurable)
Operation.....	Fail Safe (De-energised in alarm condition)
Relay Rating.....	5 A @ 230 VAC, 5 A @ 30 VDC

Analogue Output

Type:.....	4-20 mA/0-20 mA/0-5 V (User configurable)
Resolution:.....	Better than 0.5%
4-20mA Maximum Output Load:.....	1000 Ohms
0-20mA Maximum Output Load:.....	1000 Ohms
0-5V Minimum Output Load:.....	1000 Ohms

EMC

EMC:.....	EN 61000-6-1(2001) EN 61000-6-3(2001)
-----------	---------------------------------------

Field Mount

Dimensions:.....	160 × 166 × 73 mm (h × w × d)
Weight:.....	1 Kg
Environmental Rating:.....	IP65
Material:.....	ABS
Cable Entry:.....	4 × PG11 (2 factory fitted, 2 supplied separately)
Terminals:.....	Max conductor cross section 2.5 mm ²

Technical Support

Technical Support is available by phone, fax, or email, the details of which are shown below. Our website also features a technical support page that includes a support FAQ (Frequently Asked Questions).

Phone: +44 (0) 1726 879800
Fax: +44 (0) 1726 879801
Email: info@partech.co.uk
Website: www.partech.co.uk/techsupp

To enable us to provide quick and accurate technical support please have the following information ready when you contact our Customer Support Manager:

Controller type, serial number, and software version number.

Sensor type, and serial number.

Application details.

Description of fault.

Returning Instruments for Repair

If equipment needs to be returned to Partech for repair or service the following address should be used:

SERVICE DEPT.
PARTECH (ELECTRONICS) LTD
CHARLESTOWN
ST AUSTELL
CORNWALL
PL25 3NN
UNITED KINGDOM

Please include the following information with the returned equipment. Also ensure that sensors are adequately protected for transportation (Advice on packing can be provided by our service department).

Contact name and phone number.

Return address for equipment.

Description of fault or service required.

Any special safety precautions because of nature of application.

Preparation of Fullers Earth Solutions

The Fuller's Earth is supplied in a sealed 20g package, the package contains sufficient to make a 20,000 mg/l (20 g/l) solution when combined with 1 litre of water. Alternate solutions can be obtained by increasing the amount of water used as shown in the table below.

Solution Required (g/l)	Add pack to water (litres)
2.5	8.0
5.0	4.0
10.0	2.0
20.0	1.0
40.0	0.5

The following points should be observed when preparing and using Fullers Earth solutions:

- The water used should be freshly distilled or de-mineralised
- Ensure the container used for the solution is clean
- During preparation and use, keep the solution covered to prevent contamination
- When using the solution it must be continually stirred to ensure accurate and consistent measurements and to prevent settling

Preparation of Formazin Turbidity Standard

Health & Safety Precautions

The chemicals used when following this procedure are harmful, therefore the correct safety precautions must be carried out. During handling, avoid inhalation and contact with the eyes or skin. Wash hands thoroughly after use. Refer to the data sheets for further details of the chemicals used.

Method of Preparation

The preparation of a Formazin Turbidity Standard should be carried out with great care. Absolute cleanliness should be observed at all times to avoid any contamination of the solution.

All water used should be freshly distilled or de-mineralised. During preparation and use, keep the solution covered to prevent contamination.

1. Dissolve the Hydrazinium Sulphate 10g (32112680) into 1 litre of water. Stir the solution thoroughly.
2. Dissolve the Hexamine 100g (32112630) into 1 litre of water. Stir the solution thoroughly.
3. Pour the above solutions into a 2.5 litre Winchester or similar type amber glass bottle and mix thoroughly. Allow the mixture to stand undisturbed for 24 hours at 25°C. The resultant solution will have a turbidity of 4000 FTU.
4. Prior to use the standard should be mixed thoroughly. i.e. before pouring out the standard, shake the bottle well.

Preparation of Dilution's.

The 4000 FTU standard can be used to prepare solutions of lower values by diluting with water. The formula below can be used to calculate the ratio of water to 4000 FTU standard to produce a solution of the required value.

$$W = \frac{4000}{A} - 1$$

W = parts water to 1 part 4000 FTU standard

A = Required FTU value

The Formazin Dilution Chart provides the mixture requirements to make various solutions using the 4000 FTU standard.

Calibration

When Formazin solutions are used for calibration/testing of sensors, sufficient solution is required such that the sensor is completely immersed. When using light scatter sensors it is important that the sensor is positioned away from the sides and bottom of the container to prevent the light being reflected.

Storage Life

The turbidity standard should be stored in the Winchester bottle and kept in a cool dark place. The bottle should be labelled to identify its content and also the date of preparation should be recorded. The 4000 FTU standard has a shelf life of one year after which it should be discarded and a fresh solution should be prepared.

Solutions made by diluting the 4000 FTU standard should also be stored in suitably labelled amber glass bottles and kept in a cool dark place. Solutions above 400 FTU have a shelf life of one month after which they should be discarded. Solutions below 400 FTU should be prepared from the 4000 FTU standard daily.

Solutions can be used outside of the storage lives specified above but any results taken must acknowledge this and be accepted as less accurate. When using solutions, watch for flocculation (the particles in the solution will appear to link together), if this occurs discard the solution and prepare a fresh standard.

Declaration of Conformity

DECLARATION OF CONFORMITY

According to EN 45014

We, Partech (Electronics) Limited, Charlestown, St Austell, Cornwall, United Kingdom, declare under our sole responsibility that the product:

Product Name: 7200 Monitor
Model Number(s): 167200

to which this declaration relates is in conformity with the standards noted below:

EN 61326:1998 -Electrical equipment for measurement, control, and laboratory use—EMC requirements.

EN 61000-6-1:2001—Electromagnetic compatibility (EMC)—Part 6-1: Generic standards—Immunity for residential, commercial, and light-industrial environments.

EN 61000-6-3:2001—Electromagnetic compatibility (EMC)—Part 6-3: Generic standards—Emission standard for residential, commercial, and light-industrial environments.

following the provisions of European Directives:

89/336/EEC	Electromagnetic Compatibility Directive
92/31/EEC	Amending 89/336/EEC
93/68/EEC	Amending 89/336/EEC
73/23/EEC	Low Voltage Directive
93/68/EEC	Amending 73/23/EEC



Roger Henderson, Technical Director, February 21, 2006